

# SKM 121AR



**SEMITRANS™ M1**

## Power MOSFET Modules

### SKM 121AR

#### Features

- N Channel, enhancement mode
- Avalanche characteristics
- Short internal connections avoid oscillations
- Isolated copper baseplates
- All electrical connections on top for easy busbaring
- Large clearance (10mm) and creepage distances (13mm)
- UL recognized, file no. E 63 532

#### Typical Applications

- Switched mode power supplies
- DC servo and robot drives
- DC choppers
- UPS equipment
- Plasma cutting
- Not suitable for linear amplification



**MA**

Absolute Maximum Ratings		$T_c = 25\text{ }^\circ\text{C}$ , unless otherwise specified	
Symbol	Conditions	Values	Units
$V_{DS}$		200	V
$I_D$	$T_s = 25\text{ (80) }^\circ\text{C}$	130 (95)	A
$I_{DM}$	1 ms	390	A
$V_{GS}$		$\pm 20$	V
$T_{vj}$ ( $T_{stg}$ )		- 40 ... + 150 (125)	$^\circ\text{C}$
$V_{isol}$	AC, 1 min.	2500	V
Inverse diode			
$I_F = -I_S$		130	A
$I_{FM} = -I_{SM}$		390	A

Characteristics		$T_c = 25\text{ }^\circ\text{C}$ , unless otherwise specified			
Symbol	Conditions	min.	typ.	max.	Units
$V_{(BR)DSS}$	$V_{GS} = 0\text{ V}$ , $I_D = 0,25\text{ mA}$	200			V
$V_{GS(th)}$	$V_{GS} = V_{DS}$ , $I_D = 1\text{ mA}$	2,1	3	4	V
$I_{DSS}$	$V_{GS} = 0\text{ V}$ , $V_{DS} = 200\text{ V}$ , $T_j = 25\text{ (125) }^\circ\text{C}$		50 (300)	250 (1000)	$\mu\text{A}$
$I_{GSS}$	$V_{GS} = 20\text{ V}$ , $V_{DS} = 0\text{ V}$		10	100	nA
$R_{DS(on)}$	$V_{GS} = 10\text{ V}$ , $I_D = 80\text{ A}$		18	20	m $\Omega$
$g_{fs}$	$V_{DS} = 25\text{ V}$ , $I_D = 80\text{ A}$	60	75		S
$C_{CHC}$	$V_{GS} = 0$ , $V_{DS} = 25\text{ V}$ , $f = 1\text{ MHz}$			160	pF
$C_{iss}$			10	13	nF
$C_{oss}$			3	4,5	nF
$C_{rss}$			0,7	1	nF
$L_{DS}$				20	nH
$t_{d(on)}$	$V_{DD} = 100\text{ V}$ , $I_D = 80\text{ A}$ ,		60		ns
$t_r$	$V_{GS} = 10\text{ V}$ , $R_G = 3,3\text{ }\Omega$		60		ns
$t_{d(off)}$			240		ns
$t_f$			70		ns
Inverse diode					
$V_{SD}$	$I_F = 260\text{ A}$ ; $V_{GS} = 0\text{ V}$		1,05	1,4	V
$t_{rr}$	$T_j = 25\text{ (150) }^\circ\text{C}$		400		ns
$Q_{rr}$	$T_j = 25\text{ }^\circ\text{C}$		4,3		$\mu\text{C}$
$I_{rr}$	$T_j = \text{ }^\circ\text{C}$				A
Thermal characteristics					
$R_{th(j-c)}$	per MOSFET			0,18	K/W
$R_{th(c-s)}$	$M_s$ , surface $10\text{ }\mu\text{m}$ , per module			0,05	K/W
Mechanical data					
$M_s$	to heatsink (M6)	4		5	Nm
$M_t$	for terminals (M5)	2,5		3,5	Nm
w				130	g

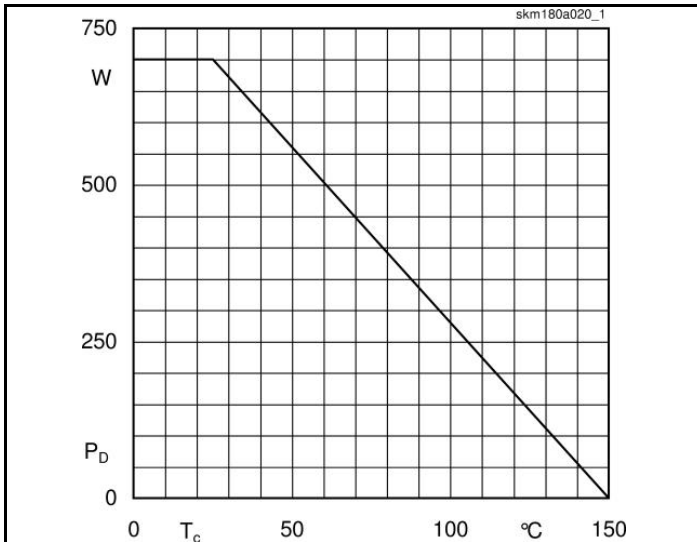

Fig. 1 Rated power dissipation vs. temperature

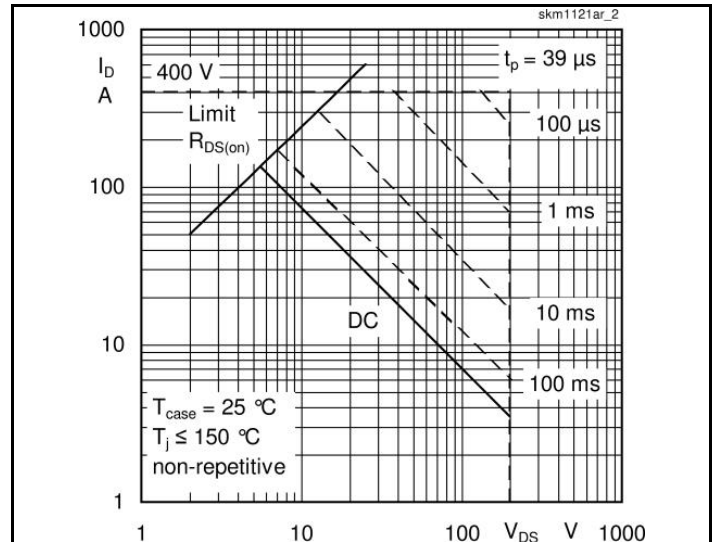

Fig. 2 Maximum safe operating area

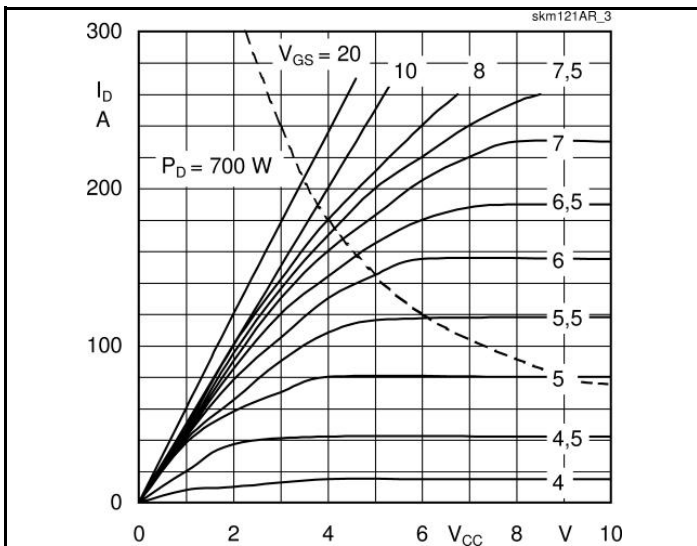

Fig. 3 Output characteristic

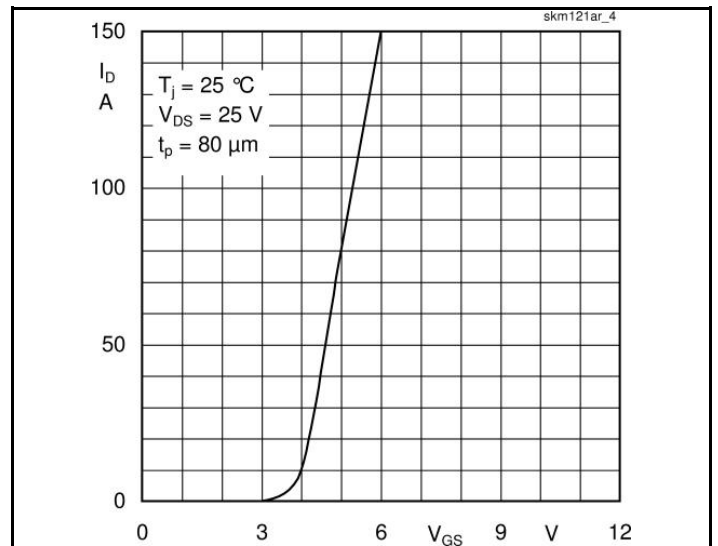

Fig. 4 Transfer characteristic

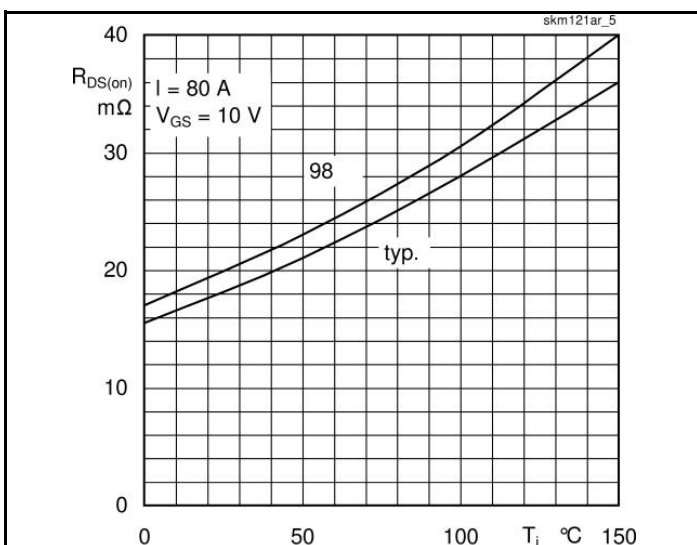

Fig. 5 On-resistance vs. temperature

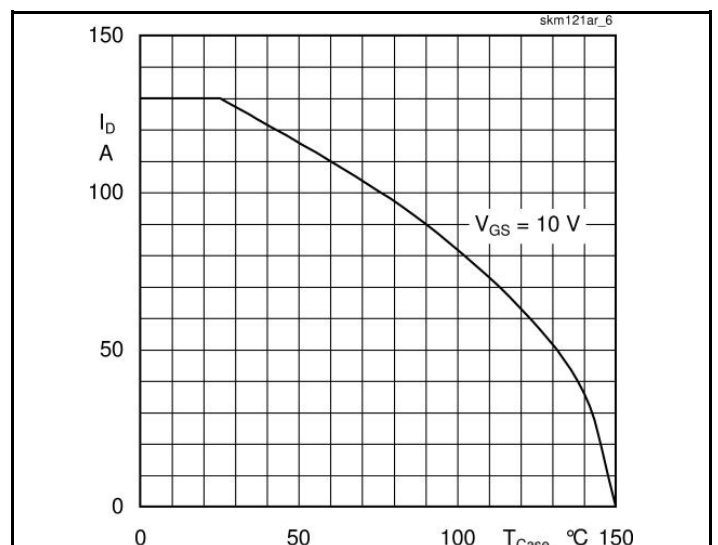
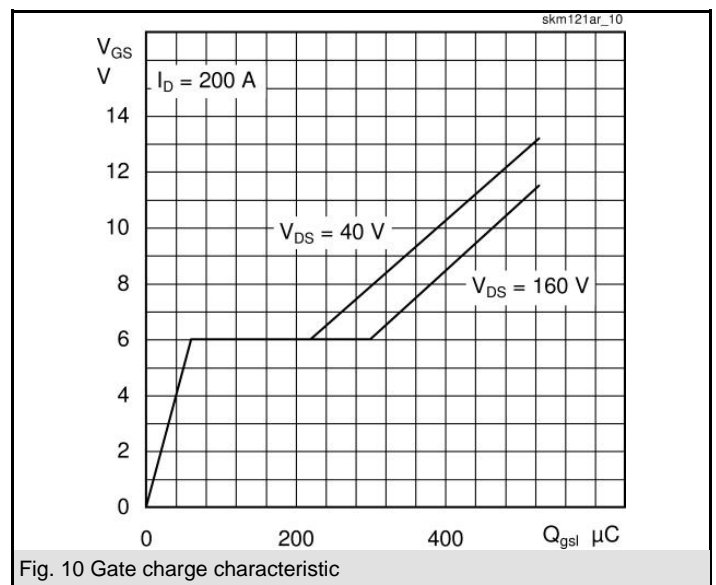
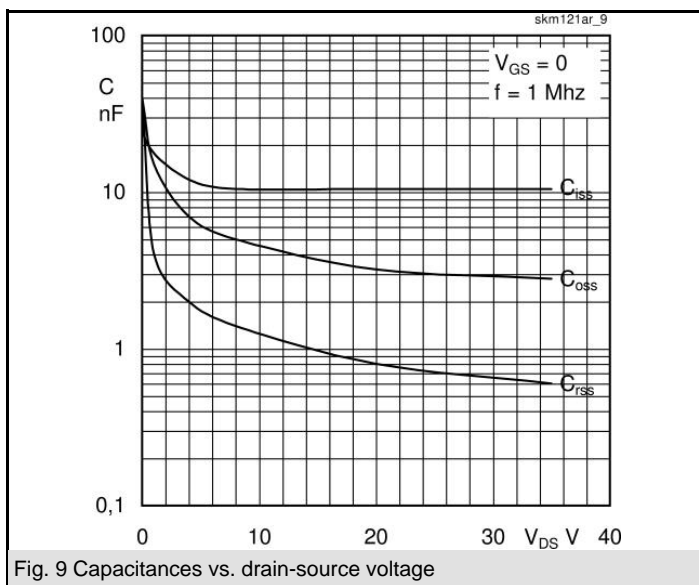
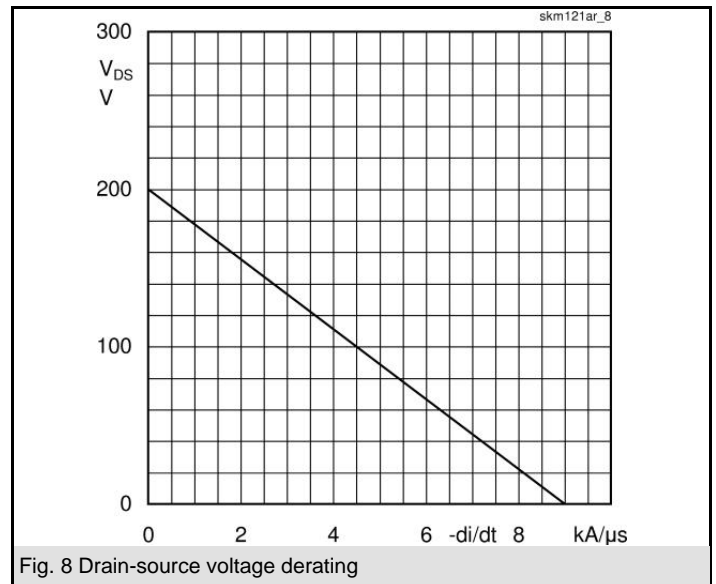
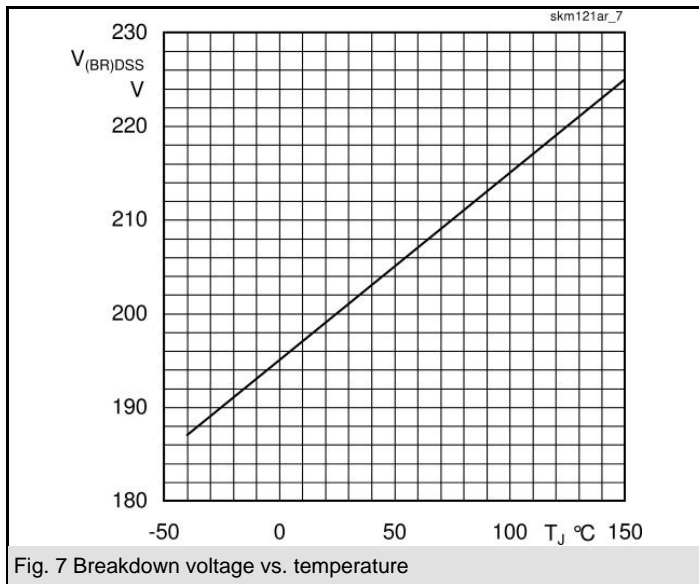

Fig. 6 Rated current vs. temperature



# SKM 121AR

UL Recognized  
File no. E 63 532

Dimensions in mm

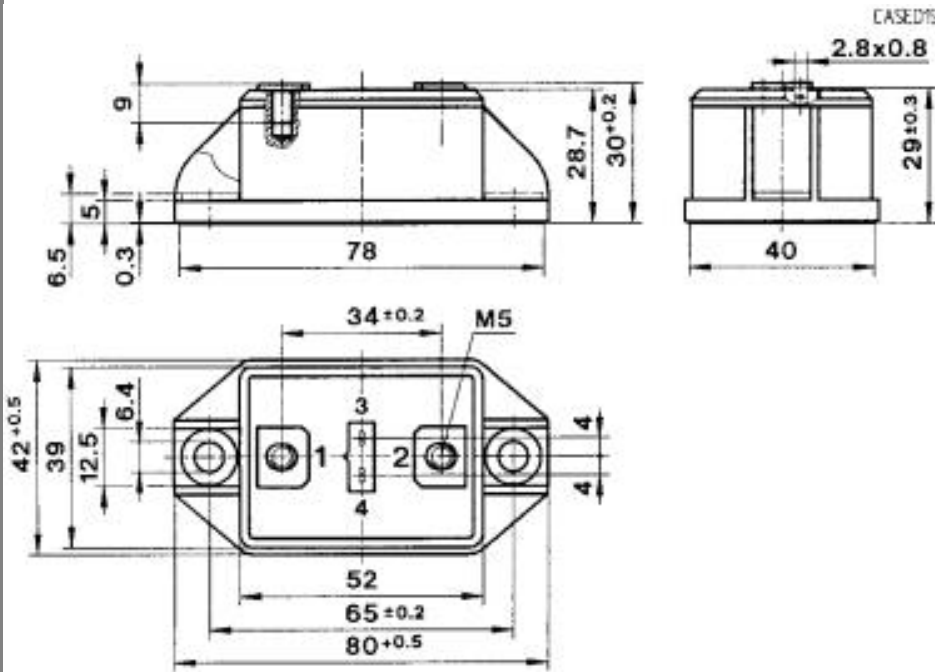

Case D 15

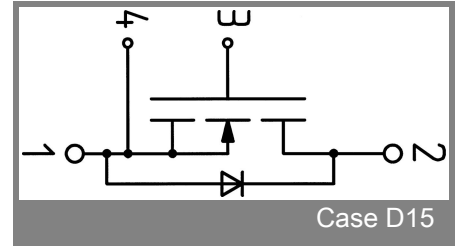

Case D15

This is an electrostatic discharge sensitive device (ESDS), international standard IEC 60747-1, Chapter IX.

This technical information specifies semiconductor devices but promises no characteristics. No warranty or guarantee expressed or implied is made regarding delivery, performance or suitability.