

# SKM 150GB12T4G

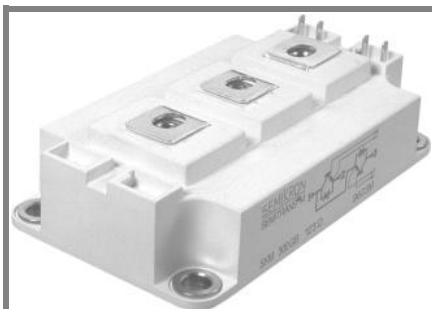

**SEMITRANS® 3**

## IGBT4 Modules

**SKM 150GB12T4G**

Target Data

### Features

- IGBT4 = 4. Generation (Trench) IGBT
- $V_{CEsat}$  with positive temperature coefficient
- High short circuit capability, self limiting to  $6 \times I_{CNOM}$
- Soft switching 4. Generation CAL diode (CAL4)

### Typical Applications

- AC inverter drives
- UPS
- Electronic welders at  $f_{sw}$  up to 20 kHz

### Remarks

- Case temperature limited to  $T_c = 125^\circ\text{C}$  max, recomm.  $T_{op} = -40 \dots +150^\circ\text{C}$ , product rel. results valid for  $T_j \leq 150^\circ$

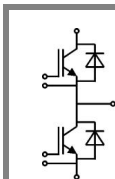

**GB**

Absolute Maximum Ratings		$T_c = 25^\circ\text{C}$ , unless otherwise specified		
Symbol	Conditions	Values	Units	
<b>IGBT</b>				
$V_{CES}$	$T_j = 25^\circ\text{C}$	1200	V	
$I_C$	$T_j = 175^\circ\text{C}$	$T_{case} = 25^\circ\text{C}$	220	A
		$T_{case} = 80^\circ\text{C}$	170	A
$I_{CRM}$	$I_{CRM} = 3 \times I_{CNOM}$	450	A	
$V_{GES}$		$\pm 20$	V	
$t_{psc}$	$V_{CC} = 600\text{ V}; V_{GE} \leq 15\text{ V}; T_j = 150^\circ\text{C}$ $V_{CES} < 1200\text{ V}$	10	$\mu\text{s}$	
<b>Inverse Diode</b>				
$I_F$	$T_j = 175^\circ\text{C}$	$T_{case} = 25^\circ\text{C}$	180	A
		$T_{case} = 80^\circ\text{C}$	135	A
$I_{FRM}$	$I_{FRM} = 3 \times I_{FNOM}$	450	A	
$I_{FSM}$	$t_p = 10\text{ ms}; \text{sin.}$	$T_j = 175^\circ\text{C}$	860	A
<b>Module</b>				
$I_{t(RMS)}$		500	A	
$T_{vj}$		-40 ... +175	$^\circ\text{C}$	
$T_{stg}$		-40 ... +125	$^\circ\text{C}$	
$V_{isol}$	AC, 1 min.	4000	V	

Characteristics		$T_c = 25^\circ\text{C}$ , unless otherwise specified					
Symbol	Conditions	min.	typ.	max.	Units		
<b>IGBT</b>							
$V_{GE(th)}$	$V_{GE} = V_{CE}, I_C = 6\text{ mA}$	5	5,8	6,5	V		
$I_{CES}$	$V_{GE} = 0\text{ V}, V_{CE} = V_{CES}$				$T_j = 25^\circ\text{C}$ mA		
$V_{CE0}$			$T_j = 25^\circ\text{C}$	0,8	0,9	V	
			$T_j = 150^\circ\text{C}$	0,7	0,8	V	
$r_{CE}$	$V_{GE} = 15\text{ V}$		$T_j = 25^\circ\text{C}$			$\text{m}\Omega$	
			$T_j = 150^\circ\text{C}$			$\text{m}\Omega$	
$V_{CE(sat)}$	$I_{Cnom} = 150\text{ A}, V_{GE} = 15\text{ V}$		$T_j = 25^\circ\text{C}_{chiplev.}$	1,85	2,05	V	
			$T_j = 150^\circ\text{C}_{chiplev.}$	2,25	2,45	V	
$C_{res}$	$V_{CE} = 25, V_{GE} = 0\text{ V}$	$f = 1\text{ MHz}$		9,3		nF	
$C_{oes}$			0,58		nF		
$C_{res}$			0,51		nF		
$Q_G$	$V_{GE} = -8\text{ V} / +15\text{ V}$		850		nC		
$R_{Gint}$	$T_j = 25^\circ\text{C}$		5		$\Omega$		
$t_{d(on)}$	$R_{Gon} = \Omega$					ns	
$t_r$							
$E_{on}$	$R_{Goff} = \Omega$					$V_{CC} = 600\text{ V}$ $I_{Cnom} = 150\text{ A}$ $T_j = 150^\circ\text{C}$ $V_{GE} = \pm 15\text{ V}$	
$t_{d(off)}$						14,8	ns
$t_f$						14,8	ns
$E_{off}$						14,8	mJ
$R_{th(j-c)}$	per IGBT			0,2	K/W		

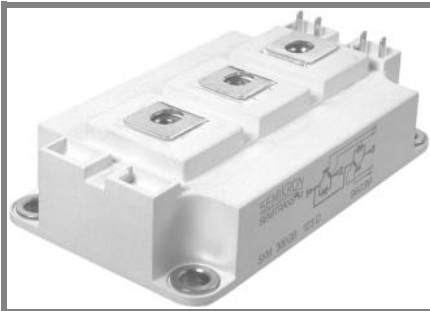

**SEMITRANS® 3**

## IGBT4 Modules

**SKM 150GB12T4G**

Target Data

### Features

- IGBT4 = 4. Generation (Trench) IGBT
- $V_{CEsat}$  with positive temperature coefficient
- High short circuit capability, self limiting to  $6 \times I_{CNOM}$
- Soft switching 4. Generation CAL diode (CAL4)

### Typical Applications

- AC inverter drives
- UPS
- Electronic welders at  $f_{sw}$  up to 20 kHz

### Remarks

- Case temperature limited to  $T_c = 125^\circ\text{C}$  max, recomm.  $T_{op} = -40 \dots +150^\circ\text{C}$ , product rel. results valid for  $T_j \leq 150^\circ$

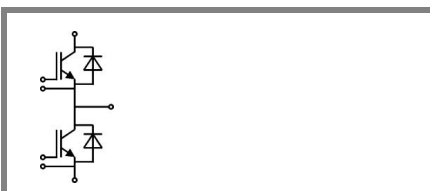

**GB**

Characteristics			min.	typ.	max.	Units
Symbol	Conditions					
<b>Inverse Diode</b>						
$V_F = V_{EC}$	$I_{Fnom} = 150 \text{ A}; V_{GE} = 0 \text{ V}$	$T_j = 25^\circ\text{C}_{chiplev.}$		2,2	2,5	V
		$T_j = 150^\circ\text{C}_{chiplev.}$		2,1	2,45	V
$V_{F0}$		$T_j = 25^\circ\text{C}$		1,3	1,5	V
		$T_j = 150^\circ\text{C}$		0,9	1,1	V
$r_F$		$T_j = 25^\circ\text{C}$		6	6,67	mΩ
		$T_j = 150^\circ\text{C}$		8	9	mΩ
$I_{RRM}$	$I_{Fnom} = 150 \text{ A}$	$T_j = 150^\circ\text{C}$				A
$Q_{rr}$						μC
$E_{rr}$	$V_{GE} = -15\text{V}$			11,3		mJ
$R_{th(j-c)}$	per diode				0,32	K/W
<b>Freewheeling Diode</b>						
$V_F = V_{EC}$	$I_{Fnom} = \text{A}; V_{GE} = \text{V}$	$T_j = ^\circ\text{C}_{chiplev.}$				V
$V_{F0}$		$T_j = ^\circ\text{C}$				V
$r_F$		$T_j = ^\circ\text{C}$				V
$I_{RRM}$	$I_{Fnom} = \text{A}$	$T_j = ^\circ\text{C}$				A
$Q_{rr}$						μC
$E_{rr}$						mJ
	per diode					K/W
<b>Module</b>						
$L_{CE}$				15	20	nH
$R_{CC'+EE'}$	res., terminal-chip	$T_{case} = 25^\circ\text{C}$			0,35	mΩ
		$T_{case} = 125^\circ\text{C}$			0,5	mΩ
$R_{th(c-s)}$	per module			0,02	0,038	K/W
$M_s$	to heat sink M6			3	5	Nm
$M_t$	to terminals M6			2,5	5	Nm
w					325	g

This is an electrostatic discharge sensitive device (ESDS), international standard IEC 60747-1, Chapter IX.

This technical information specifies semiconductor devices but promises no characteristics. No warranty or guarantee expressed or implied is made regarding delivery, performance or suitability.

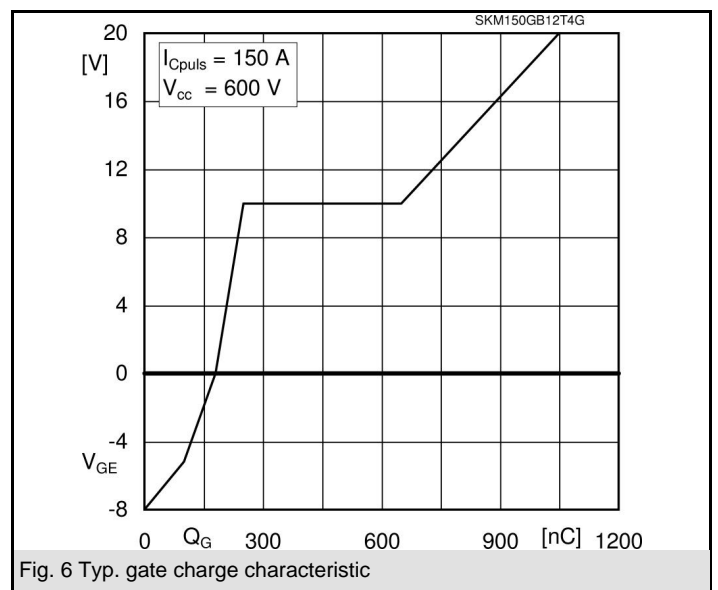
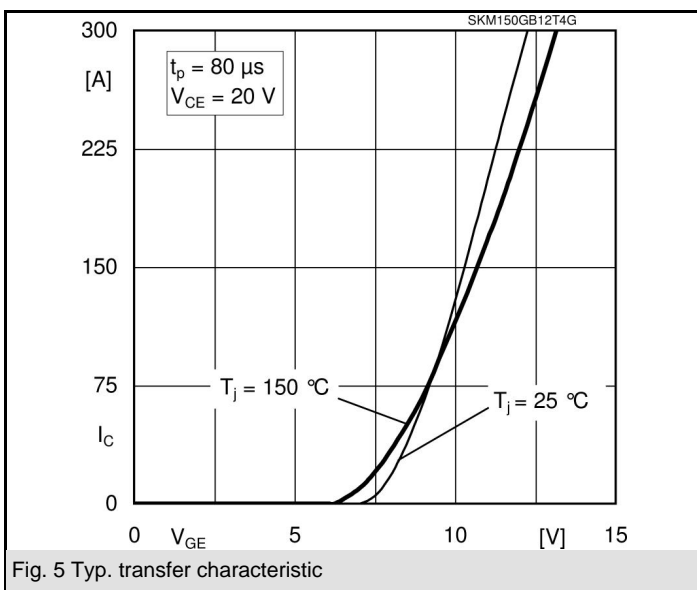
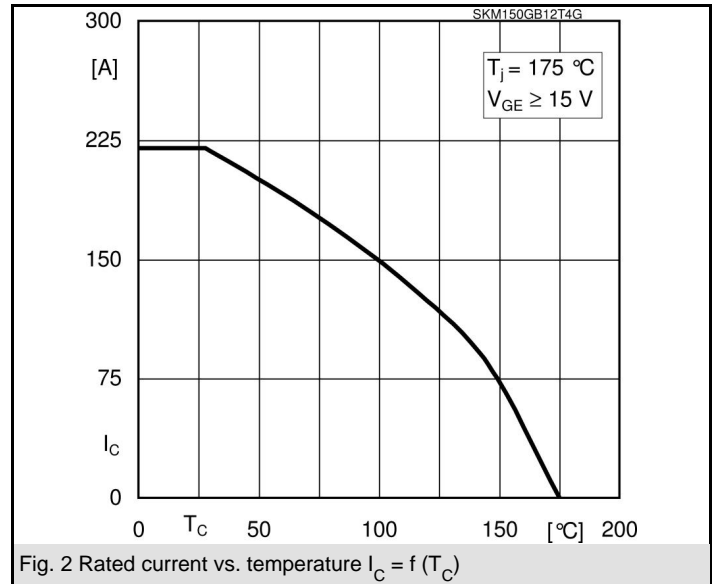
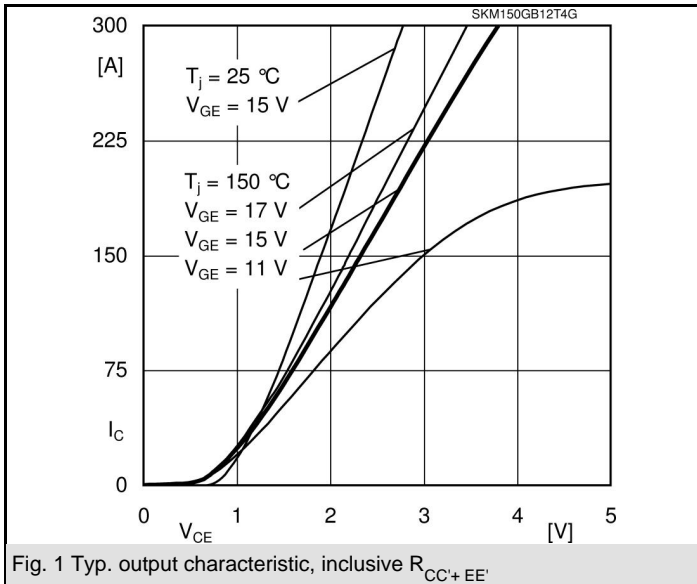

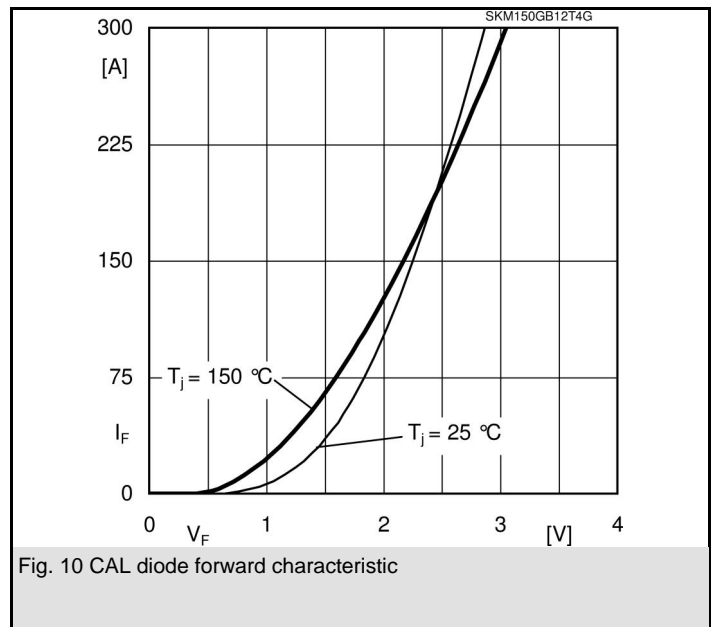
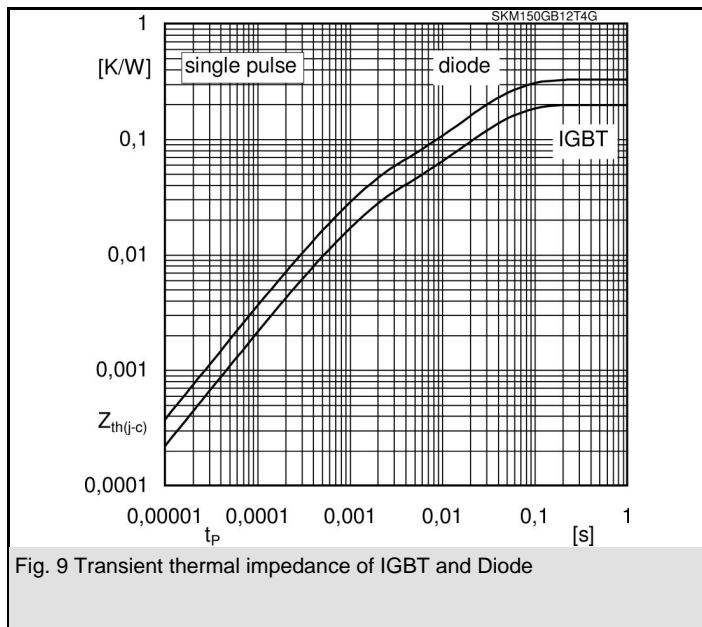

# SKM 150GB12T4G

UL recognized file

CASED56

no. E 63 532

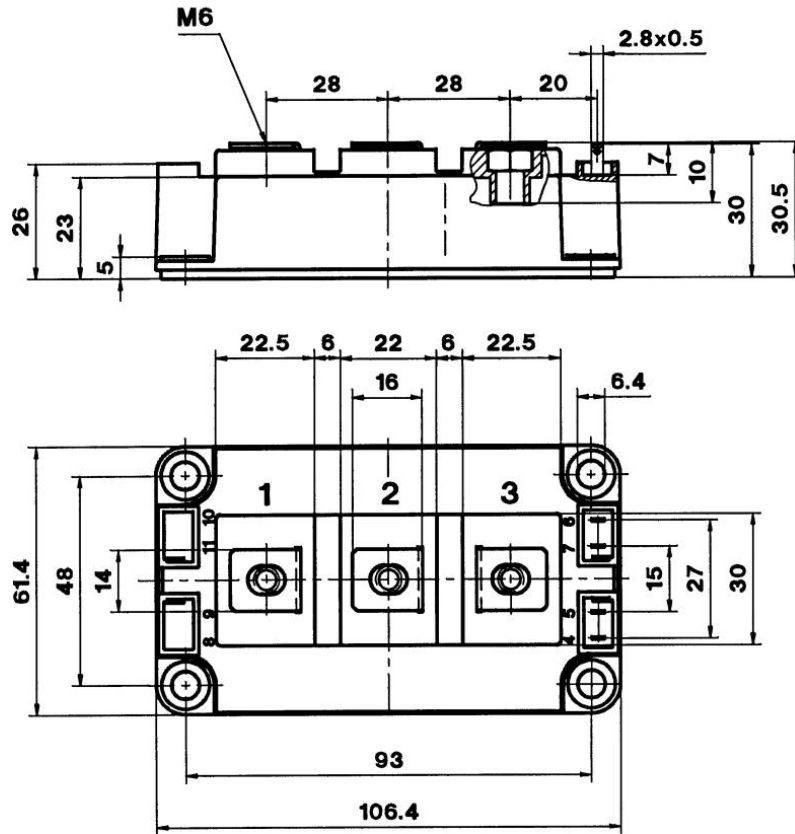

Case D56

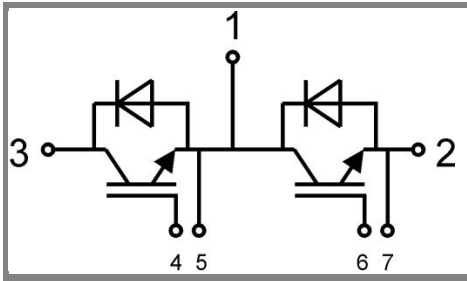

GB

Case D56